

CONNECTION DIAGRAMS FOR VERSIONS WITH EXTERNAL LED DRIVER SCHEMATY PODŁĄCZENIA DLA WERSJI Z ZEWNĘTRZNYM ZASILACZEM LED

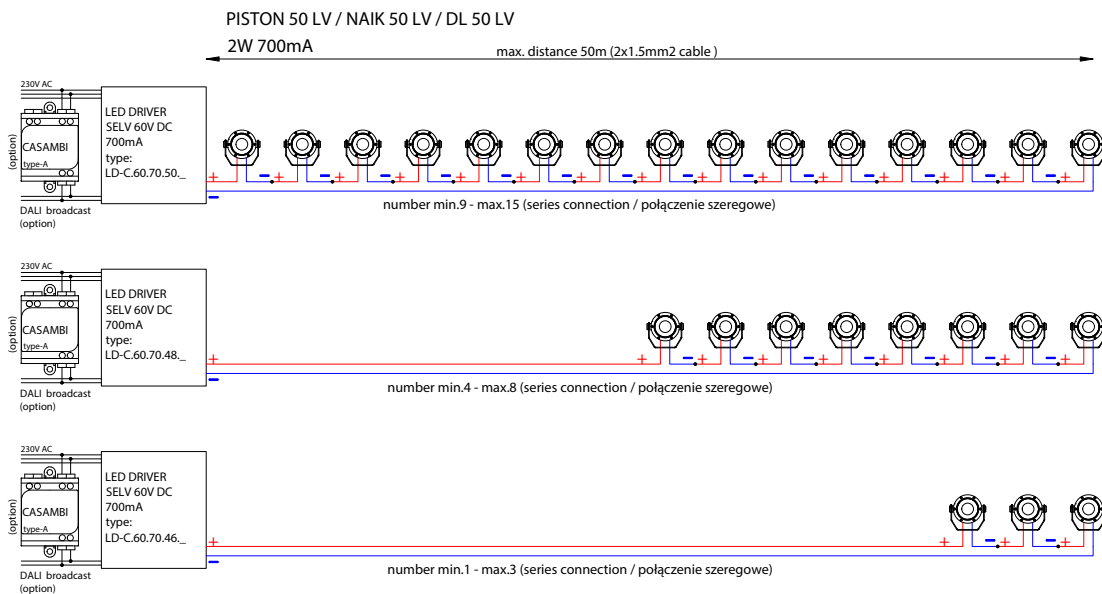
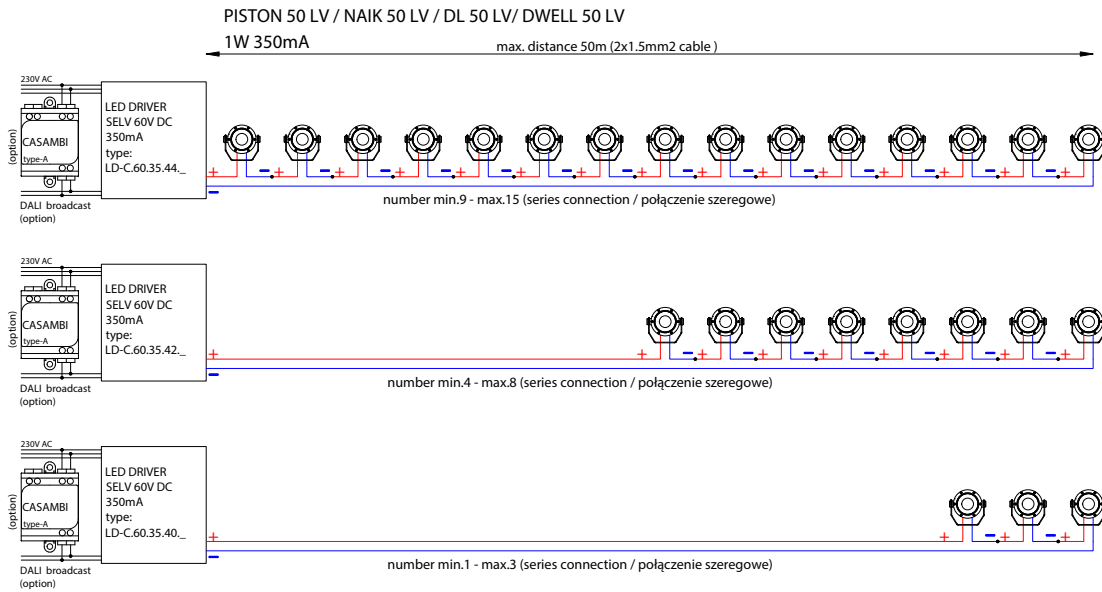

E- LED driver | zasilacz LED

0
ON-OFF

1
DALI

options | na zapytanie:
for CASAMBI use the DALI version LED DRIVER
dla CASAMBI do zastosowania zasilacz LED w wersji DALI

CONNECTION DIAGRAMS FOR VERSIONS WITH EXTERNAL LED DRIVER SCHEMATY PODŁĄCZENIA DLA WERSJI Z ZEWNĘTRZNYM ZASILACZEM LED

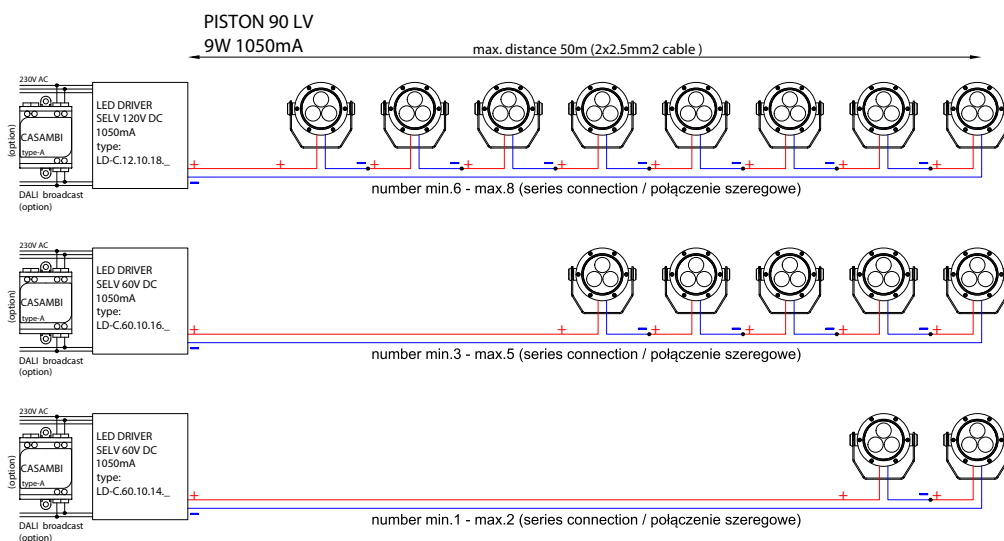
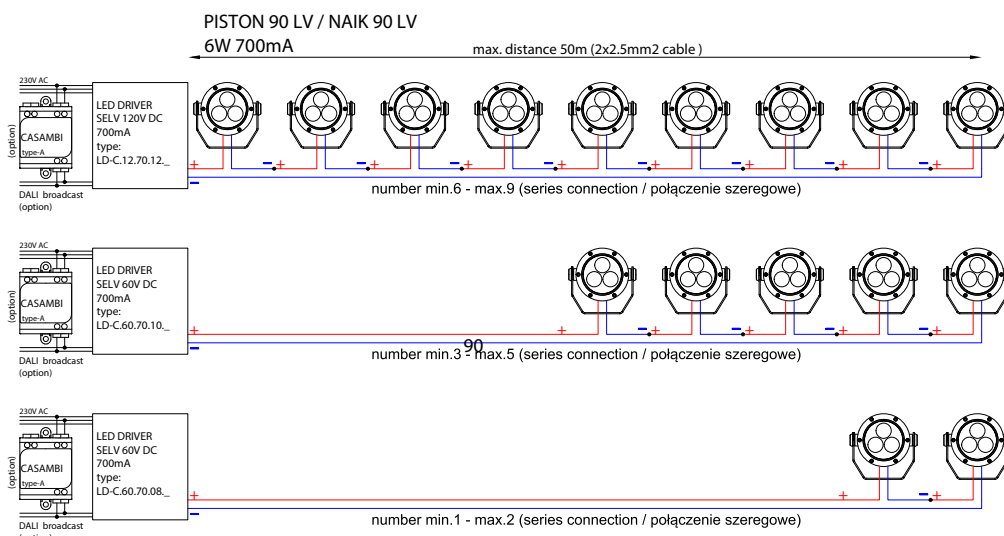
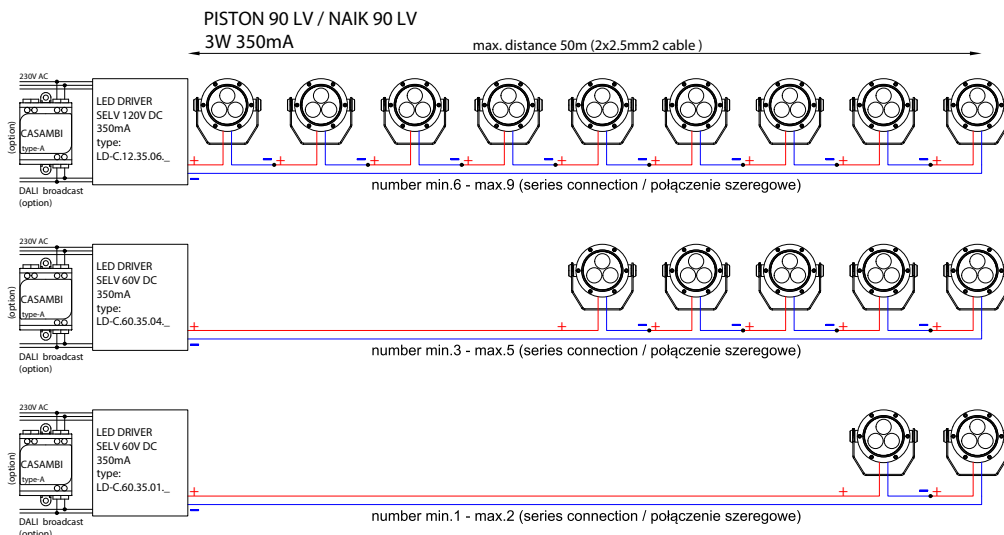

E- LED driver | zasilacz LED

0
ON-OFF

1
DALI

options | na zapytanie:
for CASAMBI use the DALI version LED DRIVER
dla CASAMBI do zastosowania zasilacz LED w wersji DALI

CONNECTION DIAGRAMS FOR VERSIONS WITH EXTERNAL LED DRIVER SCHEMATY PODŁĄCZENIA DLA WERSJI Z ZEWNĘTRZNYM ZASILACZEM LED

PISTON 140 LV / NAIK 140 LV
8W 350mA max. distance 50m (2x2.5mm² cable)

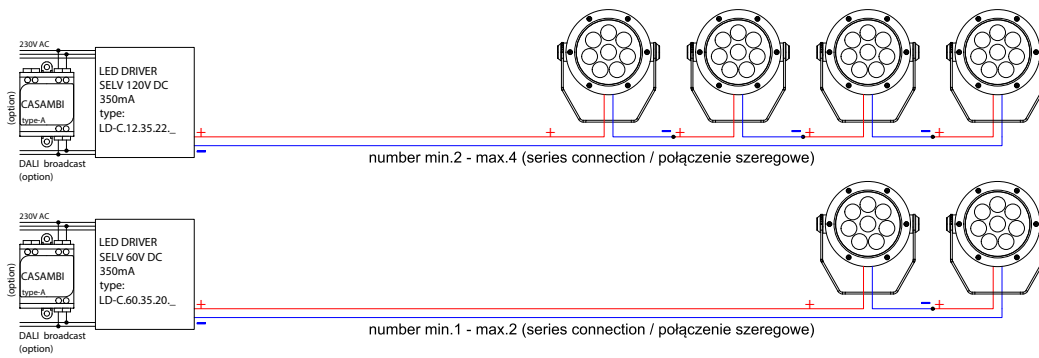

PISTON 140 LV / NAIK 140 LV
16W 700mA max. distance 50m (2x2.5mm² cable)

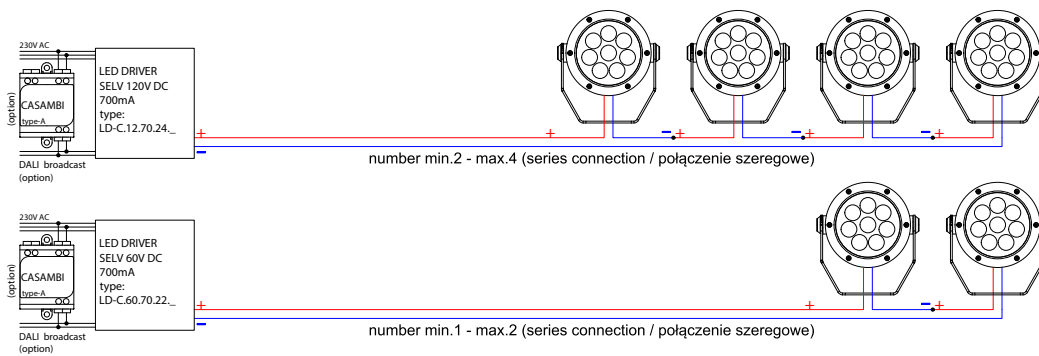

PISTON 140 LV
24W 1050mA max. distance 50m (2x2.5mm² cable)

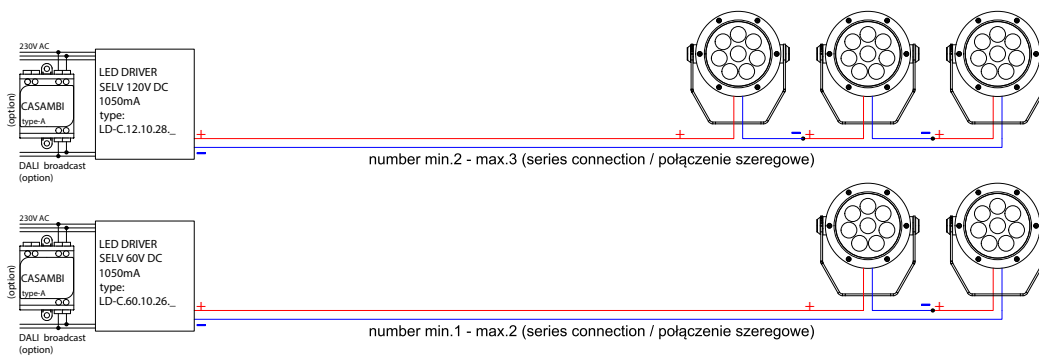

E- LED driver | zasilacz LED

0
ON-OFF

1
DALI

options | na zapytanie:
for CASAMBI use the DALI version LED DRIVER
dla CASAMBI do zastosowania zasilacz LED w wersji DALI

CONNECTION DIAGRAMS FOR VERSIONS WITH EXTERNAL LED DRIVER
SCHEMATY PODŁĄCZENIA DLA WERSJI Z ZEWNĘTRZNYM ZASILACZEM LED

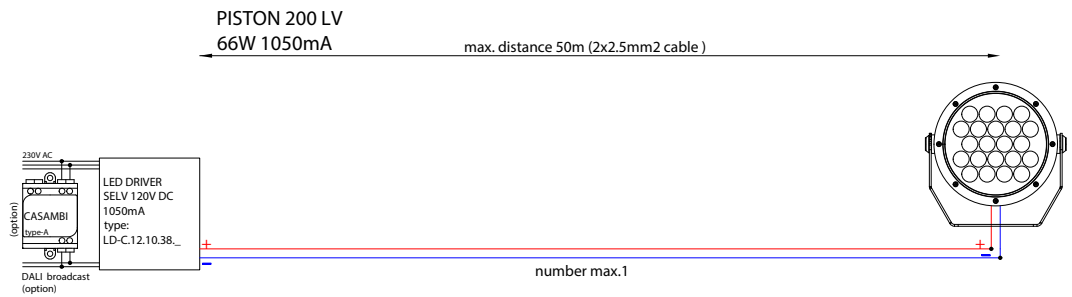
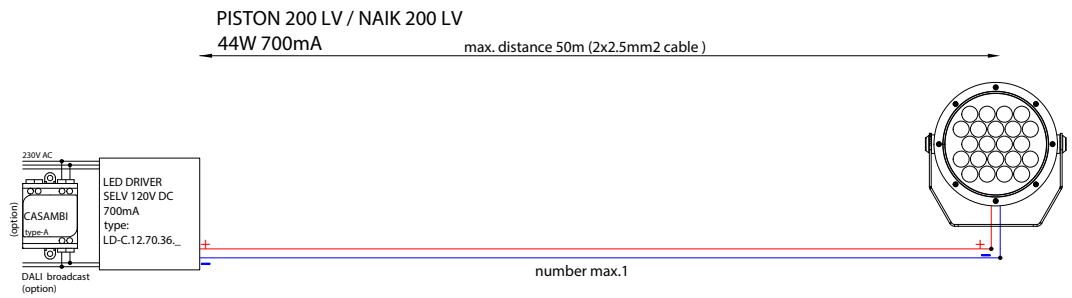
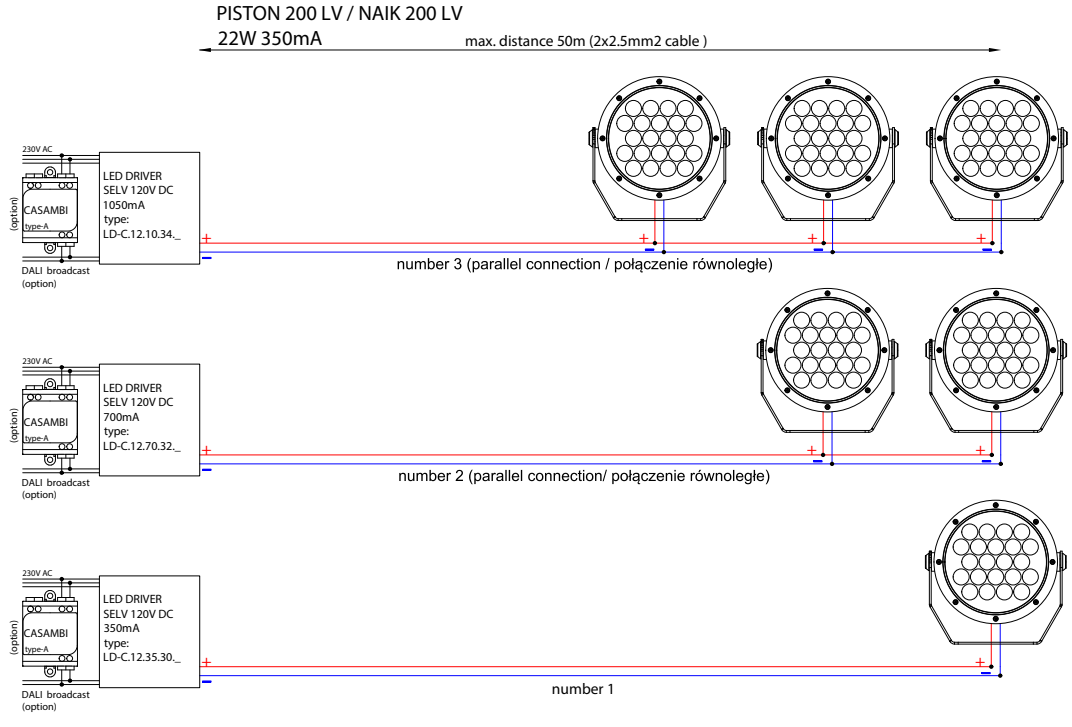

E- LED driver | zasilacz LED

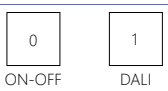

options | na zapytanie:
 for CASAMBI use the DALI version LED DRIVER
 dla CASAMBI do zastosowania zasilacz LED w wersji DALI

CONNECTION DIAGRAMS FOR VERSIONS WITH EXTERNAL LED DRIVER SCHEMATY PODŁĄCZENIA DLA WERSJI Z ZEWNĘTRZNYM ZASILACZEM LED

PISTON 90 RGBW LV/ NAIK 90 RGBW LV
4W 350mA max. distance 50m (8x1mm² cable)

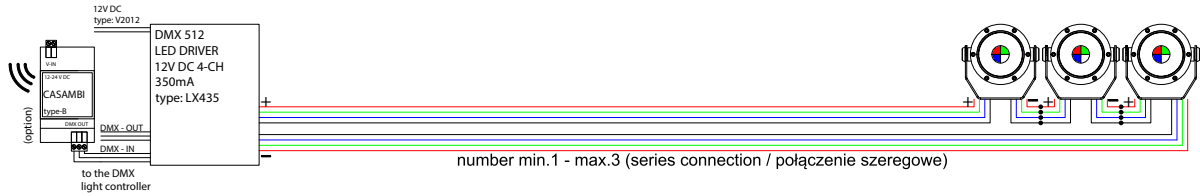
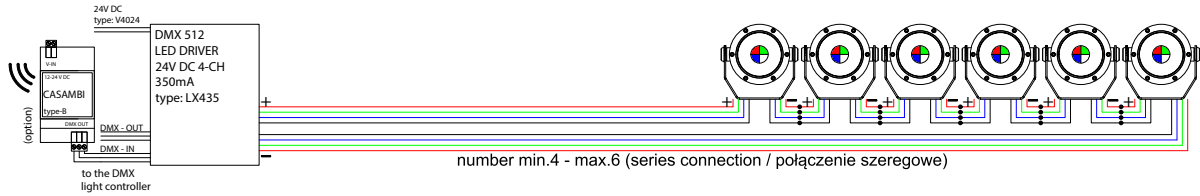
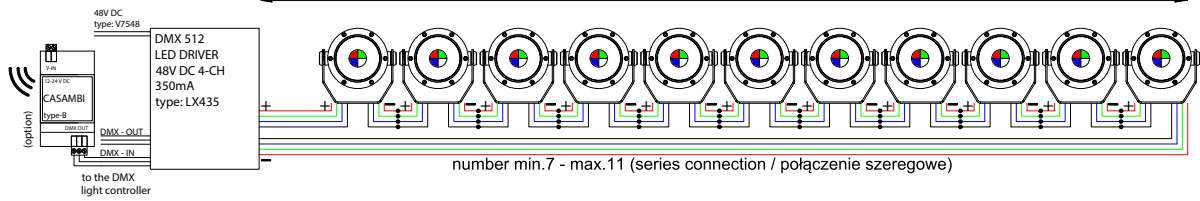

PISTON 140 RGBW LV/ NAIK 140 RGBW LV / DINX RGBW LV
16W 350mA max. distance 50m (8x1mm² cable)

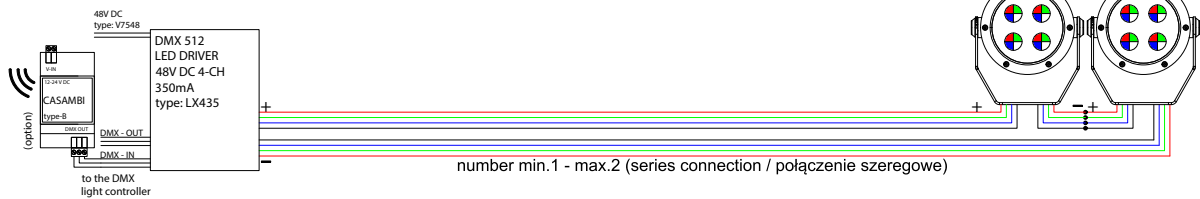

PISTON 200 RGBW LV/ NAIK 200 RGBW LV
36W 350mA max. distance 50m (8x1mm² cable)

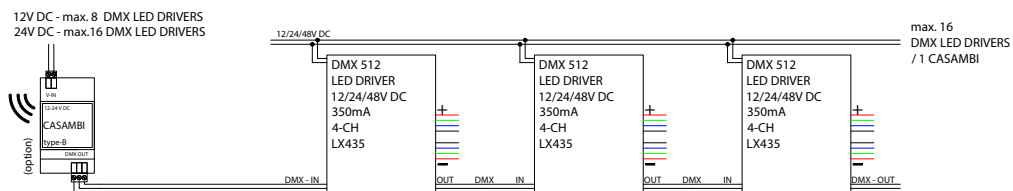
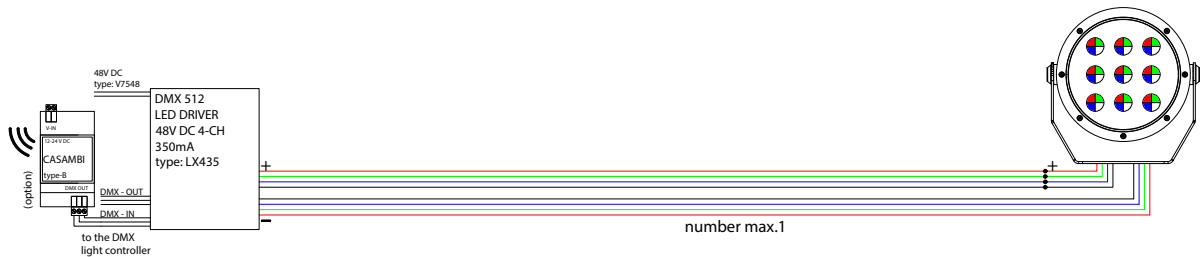

CONNECTION DIAGRAMS FOR VERSIONS WITH EXTERNAL LED DRIVER SCHEMATY PODŁĄCZENIA DLA WERSJI Z ZEWNĘTRZNYM ZASILACZEM LED

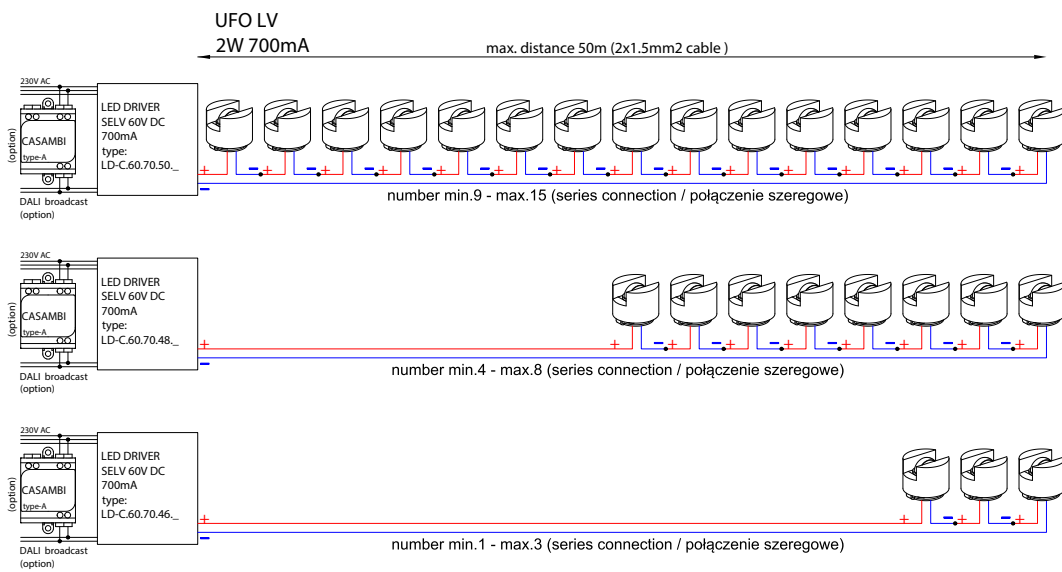
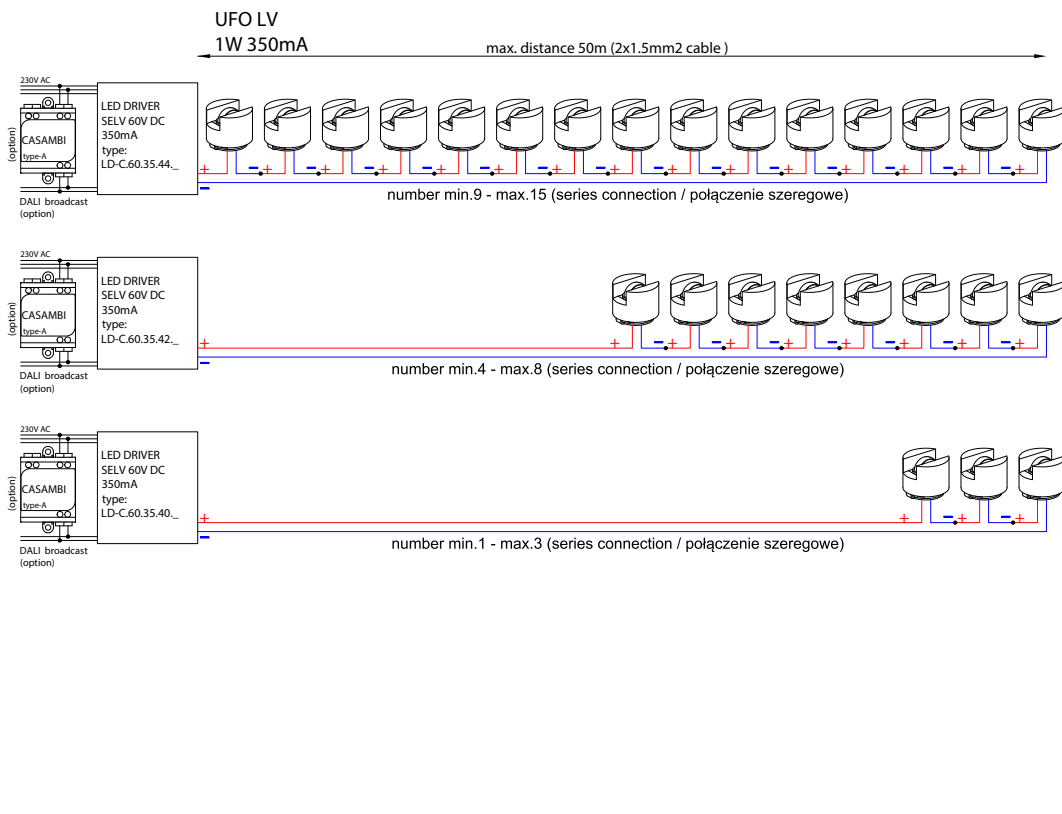

E- LED driver | zasilacz LED

0
ON-OFF

1
DALI

options | na zapytanie:
for CASAMBI use the DALI version LED DRIVER
dla CASAMBI do zastosowania zasilacz LED w wersji DALI

CONNECTION DIAGRAMS FOR VERSIONS WITH EXTERNAL LED DRIVER SCHEMATY PODŁĄCZENIA DLA WERSJI Z ZEWNĘTRZNYM ZASILACZEM LED

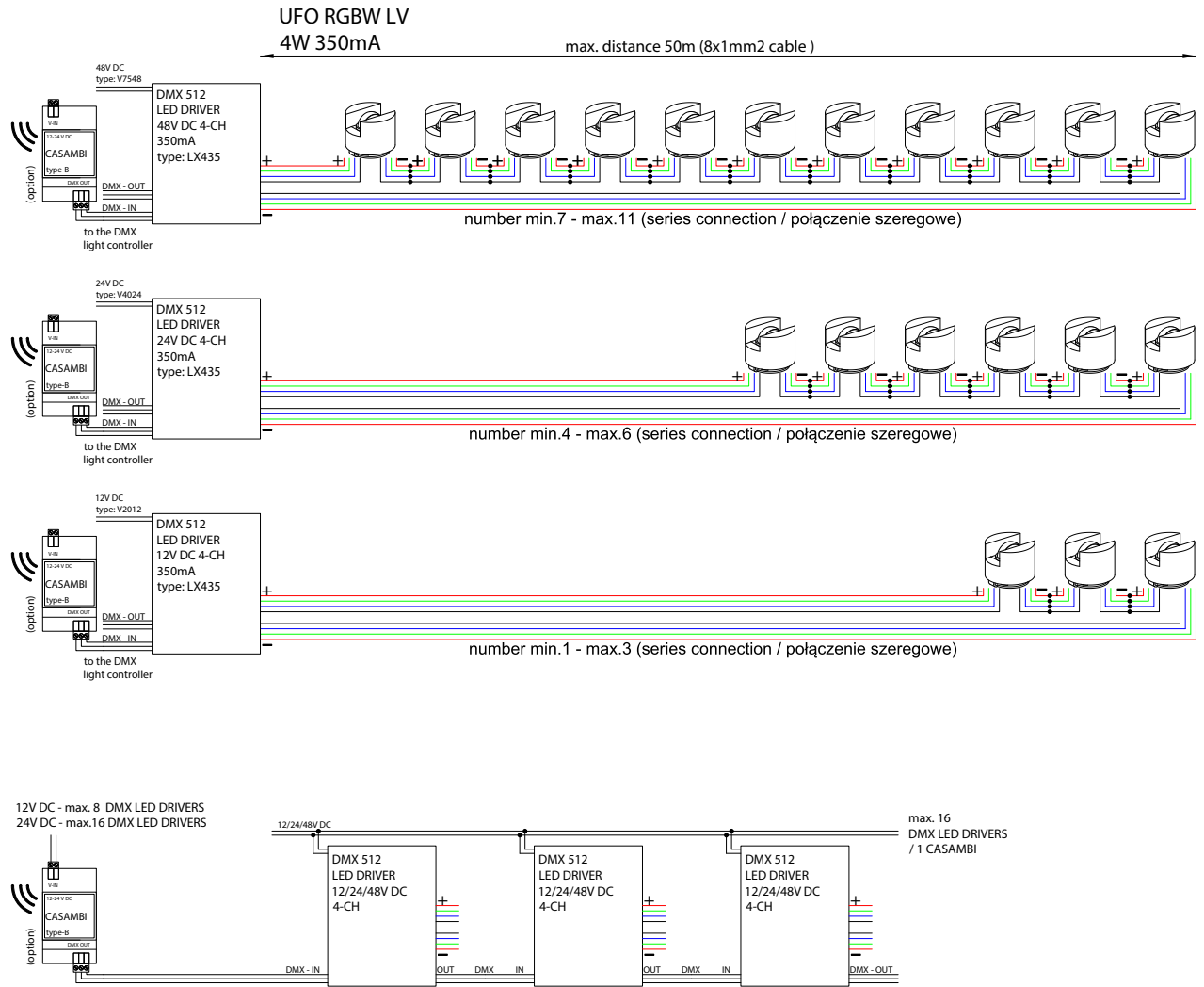

CONNECTION DIAGRAMS FOR VERSIONS WITH EXTERNAL LED DRIVER SCHEMATY PODŁĄCZENIA DLA WERSJI Z ZEWNĘTRZNYM ZASILACZEM LED

OLLIE 180 POWER LED RGBW LV / DISCOVERY 200 RGBW LV 4W 350mA

max. distance 50m (8x1mm² cable)

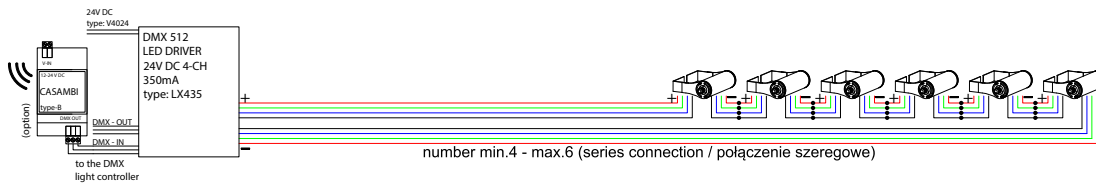
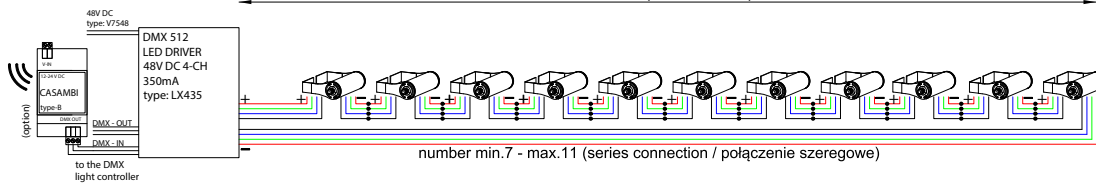

OLLIE 300 POWER LED RGBW LV 12W 350mA

max. distance 50m (8x1mm² cable)

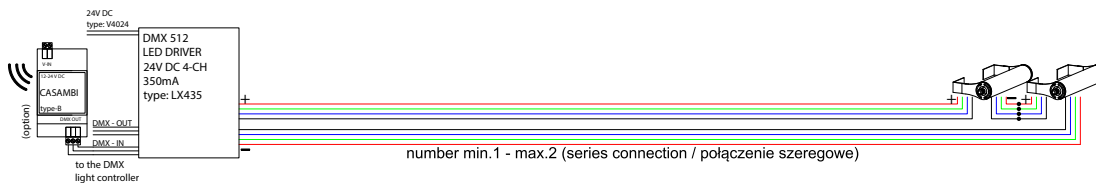
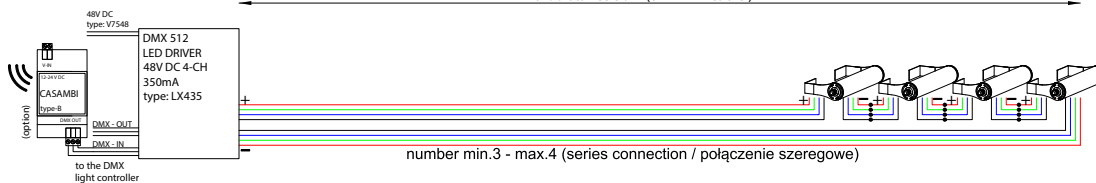

OLLIE 990 POWER LED RGBW LV 40W 350mA

max. distance 50m (8x1mm² cable)

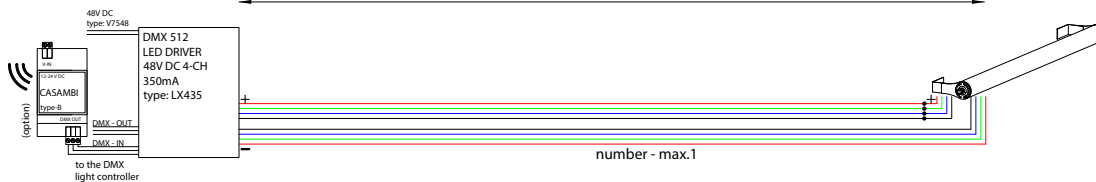

12V DC - max. 8 DMX LED DRIVERS
24V DC - max.16 DMX LED DRIVERS

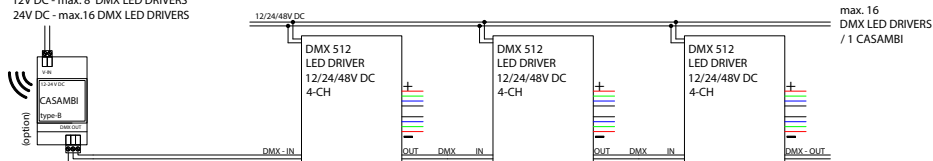

CONNECTION DIAGRAMS FOR VERSIONS WITH EXTERNAL LED DRIVER
SCHEMATY PODŁĄCZENIA DLA WERSJI Z ZEWNĘTRZNYM ZASILACZEM LED

PISTON 90 RGBW LV / NAIK 90 RGBW LV (PIXEL SYSTEM)
4W 350mA

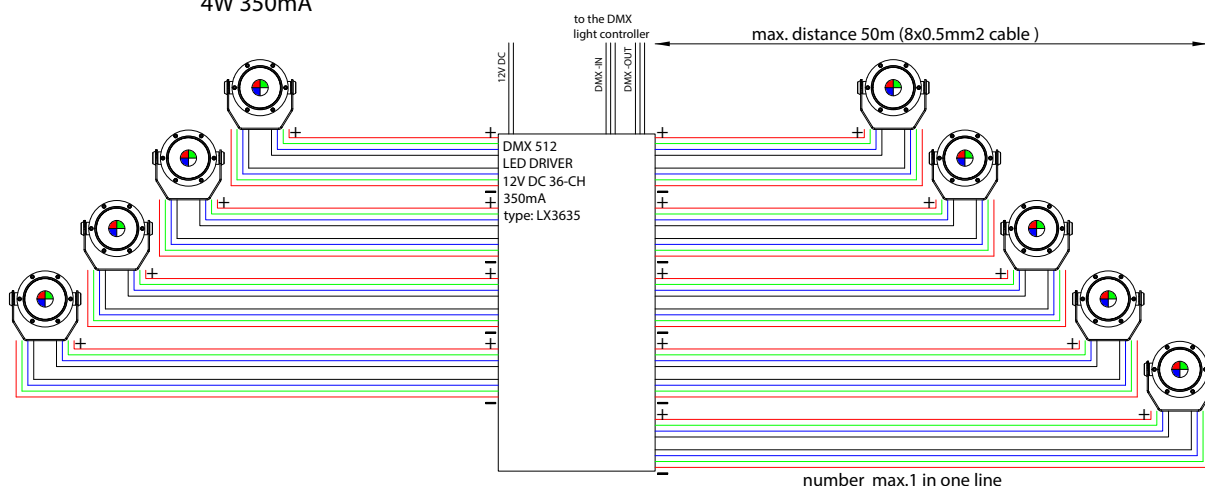

UFO RGBW LV (PIXEL SYSTEM)
4W 350mA

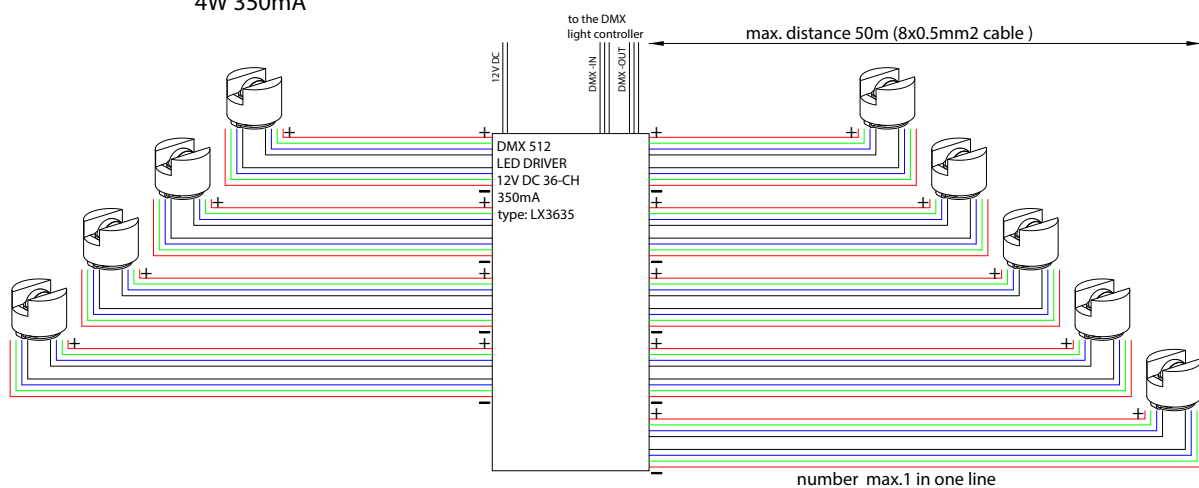

OLLIE 200 RGBW LV / DISCOVERY 200 RGBW LV (PIXEL SYSTEM)
4W 350mA

